

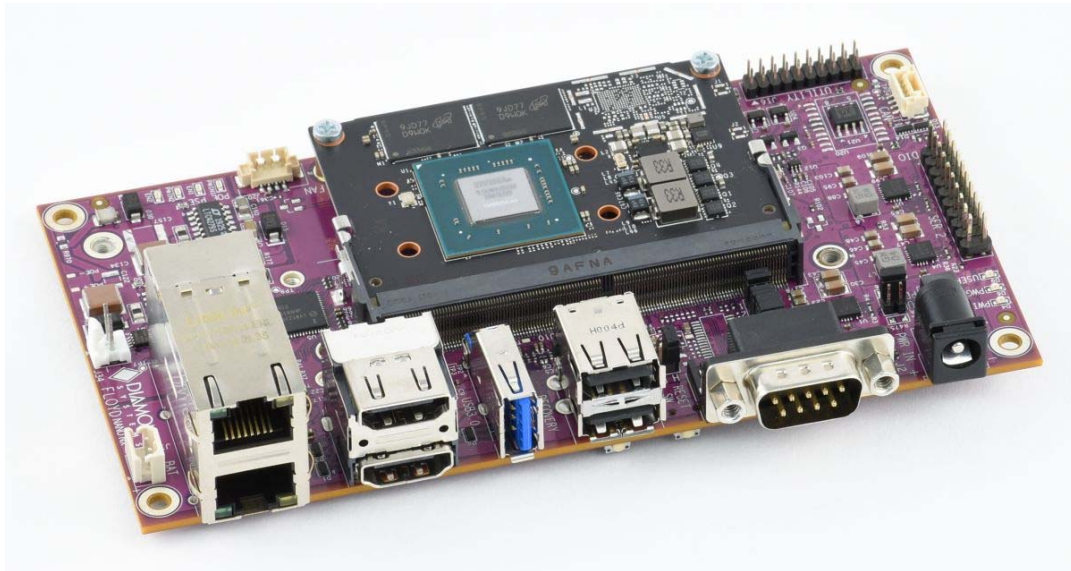

FLOYD™

NVIDIA® Jetson Nano and Xavier NX Carrier Board User Manual

Revision 1.09



**FOR TECHNICAL SUPPORT
PLEASE CONTACT:**

Email: support@diamondsystems.com

© Copyright 2020
Diamond Systems Corporation
www.diamondsystems.com

Contents

1. Important Safe Handling Information	4
2. Introduction	6
2.1 Floyd Carrier Board Overview	6
2.2 Floyd Carrier Board Models.....	7
3. JetBox Floyd System	8
4. Jetson Module Technical Specifications	9
5. Functional Overview.....	11
5.1 Power Supply Specifications	11
5.2 Camera Serial Interface (CSI)	11
5.3 Controller Area Network (CAN)	11
5.4 Digital I/O	11
5.5 Display	11
5.6 Ethernet Ports.....	12
5.7 PoE (Power over Ethernet).....	12
5.8 Audio Interface.....	12
5.9 LED Indicators	12
5.10 Micro SD Socket.....	12
5.11 PCIe Link Routing Map.....	13
5.12 PCIe M.2 SSD Socket	13
5.13 PCIe MiniCard Socket	13
5.14 Serial Port Interfaces	14
5.15 USB Ports	14
5.16 Utility Header Connector	14
6. Block Diagram.....	15
7. Connector and Jumper Locations	17
7.1 Main Component Locations.....	17
7.2 I/O Connectors, Jumpers and Led Specifications	18
7.3 Front-Facing Connectors.....	19
7.4 Expansion Slot and Switch Locations	20
8. I/O Connectors	21
8.1 Power In Connector: J3.....	21
8.2 PoE Power-In Connector: J34 (FLD-BB01 only).....	21
8.3 RTC Battery Connector: J15	21
8.4 Camera Connectors: J12, J13, J14.....	22
8.5 Controller Area Network (CAN) Connector: J11 (FLD-BB01 Only).....	23
8.6 Ethernet Connectors: J7.....	23
8.7 HDMI Connector: J5	23
8.8 USB 2.0 Port Connector: J4	24
8.9 USB 3.0 Port Connector: J6	24
8.10 Micro SD Connector: J18	24
8.11 PCIe M.2 SSD Socket (M-KEY) Connector: J19.....	25
8.12 PCIe Mini Card Connector: J17 (FLD-BB01 only).....	26
8.13 Serial Port and GPIO Connectors: J1, J9.....	27

8.14 Utility Connector: J16	28
8.15 Fan Connector: J20	28
9. I/O Connector List.....	29
9.1 I/O Cables.....	29
10. Configuration Jumpers	30
10.1 Digital I/O Enable Pull-Up Pull-Down: JP1	30
10.2 Protocol Mode Selection and Enable Termination: JP2.....	31
10.3 USB 1 Host/Device Select: JP3.....	31
11. Flashing the BSP Image.....	33
12. Thermal Solutions.....	36
13. System Assembly	38
13.1 General Description	38
13.2 Required Parts.....	38
13.3 Assembly Instructions.....	38
13.3.1 Install Jetson Module	39
13.3.2 Install Heat Sink.....	40
13.3.3 Install Fan	41
14. Specifications.....	42
15. Limited Warranty Policy.....	43

1. IMPORTANT SAFE HANDLING INFORMATION



WARNING!

ESD-Sensitive Electronic Equipment

Observe ESD-safe handling procedures when working with this product.

Always use this product in a properly grounded work area and wear appropriate ESD-preventive clothing and/or accessories.

Always store this product in ESD-protective packaging when not in use.

Safe Handling Precautions

Diamond Systems boards are designed with complex circuitry and electronic components that are ESD (Electrostatic Discharge)-sensitive. This increases the likelihood of the boards incurring accidental damage during handling, installation, and connection to other equipment.

It is highly recommended that the following precautionary measures and best practices be observed in sequential order:

- Wear an anti-static Wristband/Strap or/and an antistatic Lab Coat or/and Rubber-soled shoes.
- Spread anti-static mats over the table or work surface or/and anti-static mats on the floor.
- Unpack components and remove them from their anti-static bags only when they are ready to be used.
- Avoid ungrounded surfaces such as plastic, carpets, floors, or tables, in the work area.
- Handle boards by the edges and their metal mounting brackets. Avoid touching components on the boards and the edge connectors that connect to expansion slots.

The following information describes common causes of failure found on boards and components returned to Diamond Systems for repair. It is provided as a guideline to avoid accidental damage.

ESD Damage: This type of damage is typically impossible to detect because there is no visual sign of failure or damage. In this type of damage, the board eventually stops functioning because of some defective components. Usually, the failure can be identified and the chip can be replaced.

To prevent ESD damage, always follow proper ESD-prevention practices when handling computer boards.

Damage During Handling or Storage: Physical damage on boards also occur due to mishandling. A common observation is that of a screwdriver slipping on the board during installation, causing a gouge on the PCB surface, cutting signal traces or damaging components.

Another common observation is damaged board corners, indicating the board was dropped. This may or may not cause damage to the circuitry, depending on components located near the edges. Most Diamond System boards are designed with a minimum 25 mils clearance between the board edge and component pad. The Ground/power planes are located a minimum of 20 mils from the edge to avoid possible shorting from this type of damage. However, these design rules do not prevent damage in all situations.

Sometimes boards are stored in racks with slots that grip the edge of the board. This is a common practice for board manufacturers. Though Diamond Systems boards are resilient to damages, the components located close to the board edges can be damaged or even knocked off the board if the board lies tilted in the rack.

Diamond Systems recommends that all its boards be stored only in individual ESD-safe packaging units. If multiple boards are stored together, they should be contained in bins with dividers placed between the boards. Do not pile boards on top of each other or cram too many boards within a small location. This can cause damage to connector pins or fragile components.

Damage During Installation on a PC/104 Stack: Damage on boards can also occur while installing the board in a PC/104 Stack. A common cause of damage occurs when the connector pins are misaligned with their corresponding interfaces on the stack.

For example, during installation, if a PC/104 board pin-mapping is misaligned/shifted by 1 row or 1 column, it can cause the $\pm 12V$ power and Ground signal lines on the bus to contact the wrong pins on the board and damage components linked to the data bus lines.

Bent Connector Pins: This type of problem can be resolved by re-bending the pins to their original shape using needle-nose pliers.

The most common cause of a bent connector pin is when the board is pulled off a stack by tugging it at angles from one end of the connector to the other, to release it off the stack. Tugging the board off the stack in this manner can bend the pin(s) significantly.

A similar situation can occur when pulling a ribbon cable off a pin header. If the pins are bent too severely, bending them back can cause them to weaken or break. In this case, the connector must be replaced.

Power Damages: There are various causes of power-specific damages that can occur while handling the board. Some common causes such as –a metal screwdriver tip slipping, or a screw dropping onto the board while it is powered-up, causes a short between a power pin and a signal pin on a component.

These faults can cause over-voltage/power supply problems besides other causes described below.

To avoid such damages, assembly operations must be performed when the system is powered off.

Power Supply Wired Backwards: Diamond Systems power supplies and boards are not designed to withstand a reverse power supply connection. This will destroy almost all ICs connected to the power supply. In this case, the board will likely be irreparable and must be replaced. A chip destroyed by reverse or excessive power will often have a visible hole or show some deformation on the surface due to vaporization inside the package.

Overvoltage on Digital I/O Line: If a Digital I/O signal is connected to a voltage above the maximum specified voltage, the digital circuitry can be damaged. The acceptable voltage range, on most Diamond Systems boards connected to digital I/O signals is 0-5V, with overvoltage protection up to 5.5V (-0.5 to 5.5V). Overvoltage beyond this limit can damage the circuitry.

Other considerations are Logic Signals, which are typically generated between 12V to 24V.

If a Digital I/O Line of 12V to 24V is connected to a 5V logic chip, the chip will be damaged, and the damage could extend to other chips in the circuit.

IMPORTANT!

Always check power connections twice before powering up!

2. INTRODUCTION

2.1 Floyd Carrier Board Overview

Floyd is a family of carrier boards that turns the Nvidia Jetson Nano and Xavier NX GPU modules into complete embedded computers. Two models are available with different feature sets. Both models will work with both Jetson modules. Customization is available to fine tune the carrier board to remove unneeded features for cost reduction or to support additional features, including PCIe lane routing and CAN transceiver selection.

The following table summarizes the on-board I/O features and connector types.

<i>Feature</i>	<i>Description</i>	<i>Connector Type</i>
Modules	Jetson Nano Jetson Xavier NX	
Camera Interface	3 x4 Lane CSI-2 Interfaces	3x 30-Pin Micro Coaxial Cable Connectors
Display	1x HDMI 2.0a/b with Audio routed from the Module 1x HDMI 2.0a/b without Audio via DP-HDMI Bridge without Audio	Dual-Port Vertically Stacked HDMI Connector
Ethernet Controllers	2x PoE+ capable 10/100/1000 Mbps RJ45 with In-built Magnetics and LEDs	1x Dual Port RJ-45 PoE+ Connector
PoE Power	50V to 57V Input Supply	2-pin header
Serial Ports	2x Ports Jumper Configurable RS-232/422/485 through SP336 Transceivers	1x DB9 male connector Part of 2 x 10 pin header
USB	2x USB 2.0 1x USB 3.0	Dual-Port Vertically Stacked type A Receptacle 1x USB 3.0 Upright type A Receptacle
CAN Interface	1x CAN	1x4 JST Connector
Digital I/O	8x. Obtained using I ² C GPIO Expander	Part of 2 x 10 pin header
Mass Storage	1x mPCIe Socket 1x M.2 PCIe SSD Socket 1x Micro-SD Socket	RA PCIe Mini Card 52 Position RA M.2 2280 Push-pull R/A Type
Fan	1 Fan Connector with tachometer and PWM control	1 x4 SMD Connector
RTC Battery	3V Power Input	1x2 Connector
Utility Connector	Force recovery, Power button, Reset, I ² C (3.3V), SPI (3.3V), Debug UART, Force Off	2 x 10 pin header
<i>Operating System</i>		
Linux Kernel Version 4.9.140		
<i>Mechanical, Electrical, and Environmental Properties</i>		
Form-Factor	L 5.8" x W 3.04" (147mm x 77mm).	
Power Input Range	7V to 24V Wide Input Supply	DC Barrel Jack
Operating Temperature	-25°C to +75°C Ambient	
Cooling Mechanism	Heat sink, optional fan (optional accessories)	

2.2 Floyd Carrier Board Models

The Floyd carrier board is available in two models:

1. FLD-BB01 full feature with PoE support and minicard socket
2. FLD-BB02 low-cost model with reduced feature set

<i>Feature</i>	<i>FLD-BB01</i>	<i>FLD-BB02</i>
Camera CSI 4-Lane	3	3
CAN	Xavier NX Module only	No
Gigabit Ethernet	2	1
GPIO 3.3V	8	8
HDMI	2	1
M.2 PCIe Socket	PCIe x1	PCIe x4
MiniCard, PCIe Socket	Yes	No
PoE	Yes	No
SD Card	Yes	Yes
Serial Interface	2x RS 232/422/485	1 x RS-232 1 x RS-232/485
USB 3.0	1	1
USB 2.0	2	2

3. JETBOX FLOYD SYSTEM

JETBOX-FLOYD is a compact Nvidia Jetson AI computing platform ready to deploy. It includes the Jetson Nano or NX module installed on our **FLOYD** carrier board with a Linux OS installed and preconfigured to support all the I/O on Floyd.

The system is available multiple standard configurations to meet a range of customer needs. The 01 full-feature models feature dual Ethernet ports with PoE support using an external power injector, two multi-protocol serial ports, dual HDMI displays, and a PCIe minicard socket. The 02 low-cost models have fewer baseline I/O features but offer a faster-performance PCIe x4 NVME M.2 socket. Both models will support one channel of CAN 2.0B with the Xavier NX module installed.

Jetbox-Floyd features multiple expansion sockets for additional I/O and storage capacity to meet a wide range of application needs. Dual SMA antenna cutouts support the installation of wifi and cellular modem modules for network connectivity. The enclosure is DIN rail mountable or can be used in a “table top” scenario.

The system is compatible with both 12V and 24V DC power supplies. A 12VDC universal AC adapter is included with the system. Visit www.diamondsystems.com/products/jetboxfloyd for more details.



Jetbox-Floyd is available in four standard baseline configurations of Jetson module and baseboard features:

Feature	JB-FLD-NAO-01	JB-FLD-NAO-02	JB-FLD-XNX-01	JB-FLD-XNX-02
Jetson module	Nano	Nano	Xavier NX	Xavier NX
Gigabit Ethernet	2	1	2	1
PoE	Both ports	No	Both ports	No
HDMI	2	1	2	1
Camera CSI 4-lane	3	3	3	3
USB 3.0	1	1	1	1
USB 2.0	2	2	2	2
M.2 2280 socket	PCIe x1	PCIe x4	PCIe x1	PCIe x4
Minicard socket	Full size PCIe	No	Full size PCIe	No
SD card	Yes	Yes	Yes	Yes
GPIO 3.3V	8	8	8	8
Serial	2x RS-232/422/485	1x RS-232 1x RS-232/485	2x RS-232/422/485	1x RS-232 1x RS-232/485
CAN 2.0	No	No	1	No

4. JETSON MODULE TECHNICAL SPECIFICATIONS

Below is a high level summary of Jetson module features. Please visit nvidia.com or search online for more complete information on the Jetson Nano and Xavier NX GPU modules.

<i>Feature</i>	<i>Description</i>		
	<u>Jetson Nano</u>	<u>Jetson Xavier NX</u>	
Processing			
AI Performance	472 GFLOPs @ 10 W	14 TOPS (INT8) @ 10 W	21 TOPS (INT8) @ 15 W
	472 GFLOPs		
SoC	NVIDIA Tegra X1 Series	NVIDIA Xavier	
GPU	NVIDIA Maxwell Architecture with 128 NVIDIA CUDA® Cores @ 921MHz 0.5 TFLOPs (FP16)	384-core NVIDIA Volta™ GPU with 48 Tensor Cores	
CPU	64-bit Quad-core ARM A57 @ 1.43GHz Quad-core ARM Cortex®-A57 CPU Complex	6-core NVIDIA Carmel 6-Core Arm® v8.2 64-bit CPU, 6 MB L2 + 4 MB L3	
Deep Learning Accelerator	–	(2x) NVIDIA Deep Learning Accelerator (NVDLA) Engines	
Memory	4GB 64-bit LPDDR4 @ 1600MHz, 25.6 GB/s	8 GB 128-bit LPDDR4x @ 1600 MHz, 51.2GB/s	
Video Encode	4Kp30 (4x) 1080p30 (2x) 1080p60 (HEVC) 50MP/Sec 1x 4K @ 30 (HEVC) 2x 1080p @ 60 (HEVC) 4x 1080p @ 30 (HEVC); 4x 720p @ 6 (HEVC) 9x 720p @ 30 (HEVC)	2x 464MP/Sec (HEVC) 2x 4K @ 30 (HEVC) 6x 1080p @ 60 (HEVC) 14x 1080p @ 30 (HEVC)	
Video Decode	4Kp60 (2x) 4Kp30 (8x) 1080p30 (4x) 1080p60, 500MP/sec 1x 4K @ 60 (HEVC) 2x 4K @ 30 (HEVC) 4x 1080p @ 60 (HEVC) 8x 1080p @ 30 (HEVC) 9x 720p @ 60 (HEVC)	2x 690MP/sec (HEVC) 2x 4K @ 60 (HEVC) 4x 4K @ 30 (HEVC) 12x 1080p @ 60 (HEVC) 16x 1080p @ 30 (H.264) 32x 1080p @ 30 (HEVC)	
Vision Accelerator	–	7-way VLIW Processor	
Interfaces			
Camera Expansion Header	Up to 4 Cameras 12 Lanes (3 x 4 or 4 x 2) MIPI CSI-2 D-PHY 1.1 (1.5 Gb/s Per Pair)	Up to 6 Cameras (24 via Virtual Channels) 12 Lanes MIPI CSI-2 D-PHY 1.2 (Up to 30 Gbps)	
Connectivity	Wi-Fi (Requires External Chip) 1 Gigabit Ethernet, M.2 Key E	1 Gigabit Ethernet, MAC, Reduced Gigabit Media Independent (RGMII) Interface	
Display	HDMI 2.0, DisplayPort eDP 1.4	2 Multi-Mode DP 1.4/eDP 1.4/HDMI 2.0	
Miscellaneous I/O's	(3x) I ² C (2x) SPI UART I ² S GPIOs GPIO, I ² C, I ² S, SPI, UART	UFS, I ² S, I ² C, SPI, CAN, GPIOs, UART, SD	
Networking	10/100/1000 BASE-T Ethernet	10/100/1000 BASE-T Ethernet	
PCIe	1 x4 (PCIe Gen2)	1 x1 (PCIe Gen3) + 1 x4 (PCIe Gen4), Total 144 GT/s* (PCIe Gen3, Root Port & Endpoint)	
Storage	16 GB eMMC 5.1 MicroSD Card (16GB UHS-1 Recommended Minimum)	16 GB eMMC 5.1	
USB	1x USB 3.0, 3x USB 2.0	1x USB 3.1, 3x USB 2.0	
Miscellaneous I/O's	GPIO, I ² S, I ² c, SPI, UART	GPIO, I ² S, I ² c, SPI, UART	

<i>Mechanical, Electrical, and Environmental Properties</i>		
Form-Factor	L 2.74" X W 1.77" (69.6 mm x 45 mm)	L 2.74" X W 1.77" (69.6 mm x 45 mm)
Connector	260-Pin SO-DIMM Connector	260-Pin SO-DIMM Connector
Cooling Solution	Heat sink / fan sink available	Heat sink / fan sink available
Voltage Input	5V	5V
Power Input Range	5W / 10W	10W / 15W
Ambient Operating Temperature Range	-25°C to 75°C	-25°C to 75°C

5. FUNCTIONAL OVERVIEW

The following section provides functional details of the key sub-systems implemented on the Floyd carrier board.

5.1 Power Supply Specifications

The Floyd carrier board accepts a wide input voltage range of +7V to +24V. Maximum power consumption with either Nano or NX module installed and all peripherals operating is 35W. The maximum allowable reflected ripple, measured at the voltage input connector is 50 mV p-p. The input power is provided via a barrel jack with 5.5mm OD / 2.5mm ID dimensions (tip positive).

5.2 Camera Serial Interface (CSI)

The Jetson Nano module connector implements 12x CSI lanes supporting dual- and quad-lane cameras.

The carrier board supports three cameras which are interfaced through 30-pin micro-coax connectors. Each connector supports I²C and control signals to enable users directly interface the camera to the carrier board.

As of this manual revision the following cameras are tested and qualified to run on Floyd with both Nano and NX modules, and their drivers are integrated into the Diamond Systems BSP for Floyd. Although not listed or tested, many other cameras designed for Jetson Nano / NX modules should also be compatible with Floyd. For more information please contact Diamond technical support or visit www.e-consystems.com.

Vendor	Model number	Description
Econ	e-CAM55_CUMI0521_MOD	5MP normal light fixed focus
Econ	e-CAM21_CUMI290_MOD	2MP ultra-low-light fixed focus
Econ	e-CAM137A_CUMI1335_MOD	13MP normal light fixed focus

5.3 Controller Area Network (CAN)

The carrier board is equipped with a CAN interface. The interface is implemented either with a non-isolated transceiver [PCA82C251T/YM,118](#) (standard) or an isolated transceiver [ADM3053BRWZ](#) (optional, contact Diamond Systems Sales for further information). The CAN feature is available only with the NX module installed; the Nano module does not include an integrated CAN controller.

5.4 Digital I/O

Floyd integrates a TCA9538 I²C GPIO expander IC that implements eight General Purpose Input/output (GPIO) lines with 3.3V logic level drive and 5V tolerant inputs. Each GPIO line be configured individually for input or output. 10K pull-up/down resistors are provided on board and are jumper-selected.

The GPIO is available on a 2 x 10 2mm pin header combined with the second serial port.

5.5 Display

Floyd supports two HDMI 2.0 a/b video output options:

- 1x With audio
- 1x Without audio

Both video outputs terminate on a dual-port vertically stacked HDMI connector.

The Nano module natively supports 1x HDMI and 1x DisplayPort. Floyd uses a bridge chip to convert the DP port to HDMI.

5.6 Ethernet Ports

Floyd is equipped with one or two Gigabit Ethernet ports:

1. (all models) A 10/100/1000 Ethernet port routed from the module.
2. (BB01 model only) A 10/100/1000 Ethernet port derived from the [Intel WGI210IT/Intel I210](#) PCIe Ethernet controller which is accessed via x1 PCIe Lane routed from the module through a PCIe switch.

Both Ethernet ports are accessed with a dual-port vertically stacked RJ-45 jack with integrated magnetics. The jacks indicate Link, Activity, and Speed status associated with each port using integrated LEDs.

5.7 PoE (Power over Ethernet)

The PoE+ PSE (Power Sourcing Equipment) enabled Ethernet ports on the carrier board can be used to power peripherals such as PoE IP-based cameras. The two ports are compliant with 802.3at Type 2 PoE+ standards and support up to 25.5W on each port, depending on the capacity of the supplied power.

Floyd administers power negotiation between the PSE and PD controllers. The auxiliary power required for the PoE circuit is supplied by a separate input power connector. The PoE input requires a supplied voltage range of 50-57VDC.

5.8 Audio Interface

The multi-channel audio interface from the HDA controller is integrated with the HDMI interface that supports eight channels at 192kHz 24-bit audio. No separate audio analog outputs are provided on the carrier board.

5.9 LED Indicators

Floyd provides several LEDs to indicate status of various functions. LEDs are located on the top side of the board and labeled in silkscreen.

<i>General</i>	<i>Description</i>
PWIN	Power IN indicator
PWGD	Power Good indicator
USER	User control, demonstrates board is working
<i>PoE</i>	
PWIN1	Valid Power In for PoE PSE port 1
PWIN2	Valid Power In for PoE PSE port 2
EN1	Indicates Power Enabled for PoE PSE port 1
EN2	Indicates Power Enabled for PoE PSE port 2

5.10 Micro SD Socket

Floyd supports a MicroSD Card socket connector with 4-bit data at 3.3V as an additional low-cost mass storage option.

5.11 PCIe Link Routing Map

The Jetson Nano and NX module contain a PCIe x4 link for use by external devices. On the Floyd model FLD-BB01, this PCIe x4 link is routed to a PCIe switch and divided into 4 x1 links to support multiple peripherals. On the FLD-BB02, the x4 link is directly connected to the M.2 socket, enabling higher bandwidth for an installed M.2 device.

The NX module contains an additional PCIe x1 link. As a build option, the BB02 can be configured so that this lane can be brought out to the second Ethernet port. In the standard BB01 and BB02 models, this PCIe x1 link is unused.

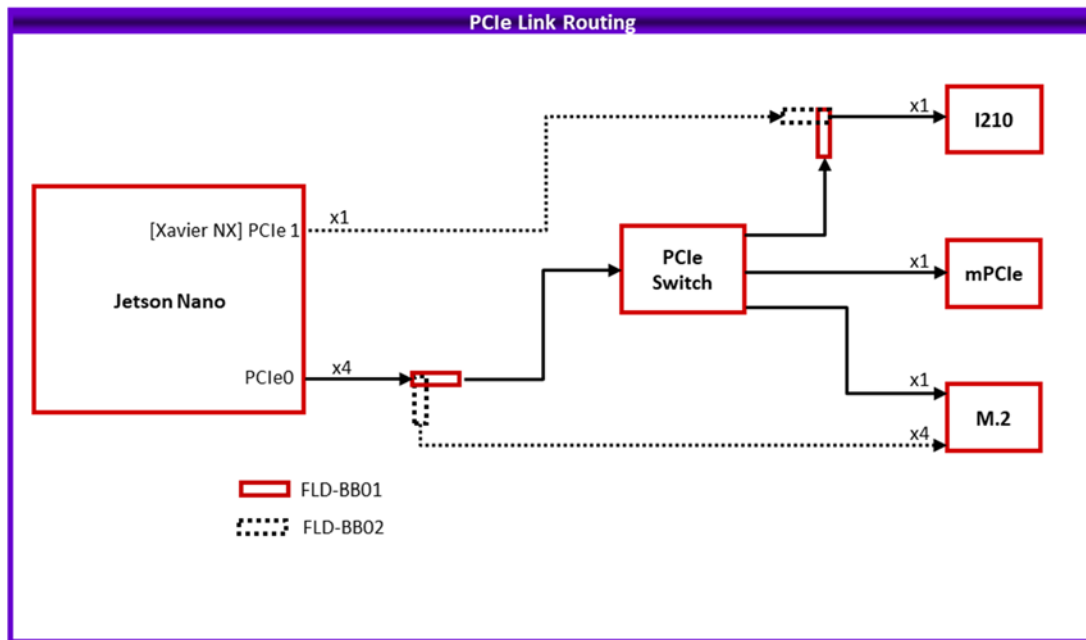

Figure 5-11: PCIe Link Routing on Floyd

5.12 PCIe M.2 SSD Socket

Floyd contains an M.2 M-Key socket that accommodates a 2280 (22 mm wide and 80 mm long) form-factor Non-Volatile Memory Express (NVMe) SSD add-in card. On model FLD-BB01, a PCIe x1 link is provided, and on FLD-BB02, a x4 link is provided.

5.13 PCIe MiniCard Socket

Floyd model FLD-BB01 contains one Mini PCIe Socket that supports full-size modules with PCIe interface only (no USB interface). On FLD-BB02, this socket is not installed.

Two threaded spacers are mounted on the board for convenient minicard installation. Two M2 screws (4-6mm length) are used to fix the module in place.

5.14 Serial Port Interfaces

Floyd carrier boards host configurable multi-protocol serial ports that are implemented using transceivers specific to the carrier board model.

- FLD-BB01:** Multi-protocol serial ports are implemented using an SP336 transceiver. Both ports can be configured together for RS-232, RS-422, or RS-485 using 2 jumpers on jumper block JP2. Both ports have the same protocol selection.
- FLD-BB02:** Serial ports are implemented using two SP3243 transceivers and one ISL83485IBZ transceiver. Port 2 can be configured for either RS-232 or RS-485 using a jumper on jumper block JP2. Port 1 is fixed RS-232 with RX/TX signals only.

On both models, 121-ohm line termination resistors for RS-422/485 protocols can be configured with jumpers on Jumper block JP2.

Serial port 1 is made available on a DB9 male panel mount connector, while serial port 2 is terminated on a 2x10 header along with the GPIO port.

As a special order option, the DB9 connector can be configured to provide access to the 8x GPIO signals instead of serial port 1.

5.15 USB Ports

Floyd provides 2x USB 2.0 ports and 1x USB 3.0 port.

- 2x USB 2.0 ports are available on a vertically stacked dual-port USB 2.0 connector.
- The upper USB 2.0 port can be used for programming during recovery mode. Jumper block JP3 is used to select host mode (normal operation) or device mode (programming operation).
- 1x USB 3.0 port terminates on an upright right-angle USB 3.0 connector. This connector also supports the USB 2.0 protocol.

5.16 Utility Header Connector

A 2x10 Utility Header connector on Floyd implements the Power button, Reset, SPI, Force Recovery, Debug TTL UART, and I²C signals. Momentary switches are also provided along the front board edge for Reset and Recovery functions. These features can be accessed via either connection.

6. BLOCK DIAGRAM

The following block diagrams illustrate the key functional blocks on the Floyd carrier board integrated with the NVIDIA Jetson Nano / NX Module.

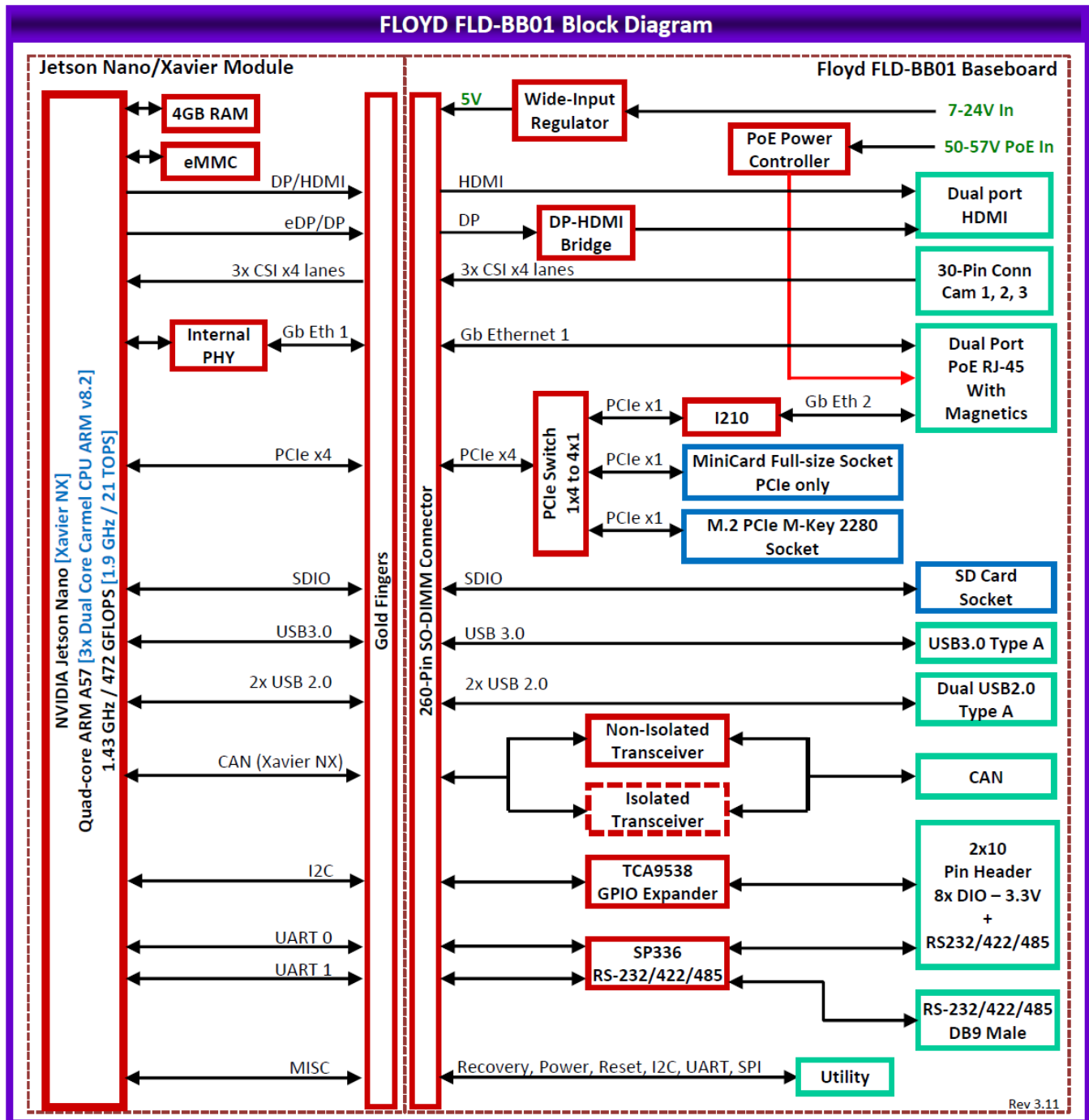

Figure 6-1: Floyd FLD-BB01 Carrier Board Functional Block Diagram

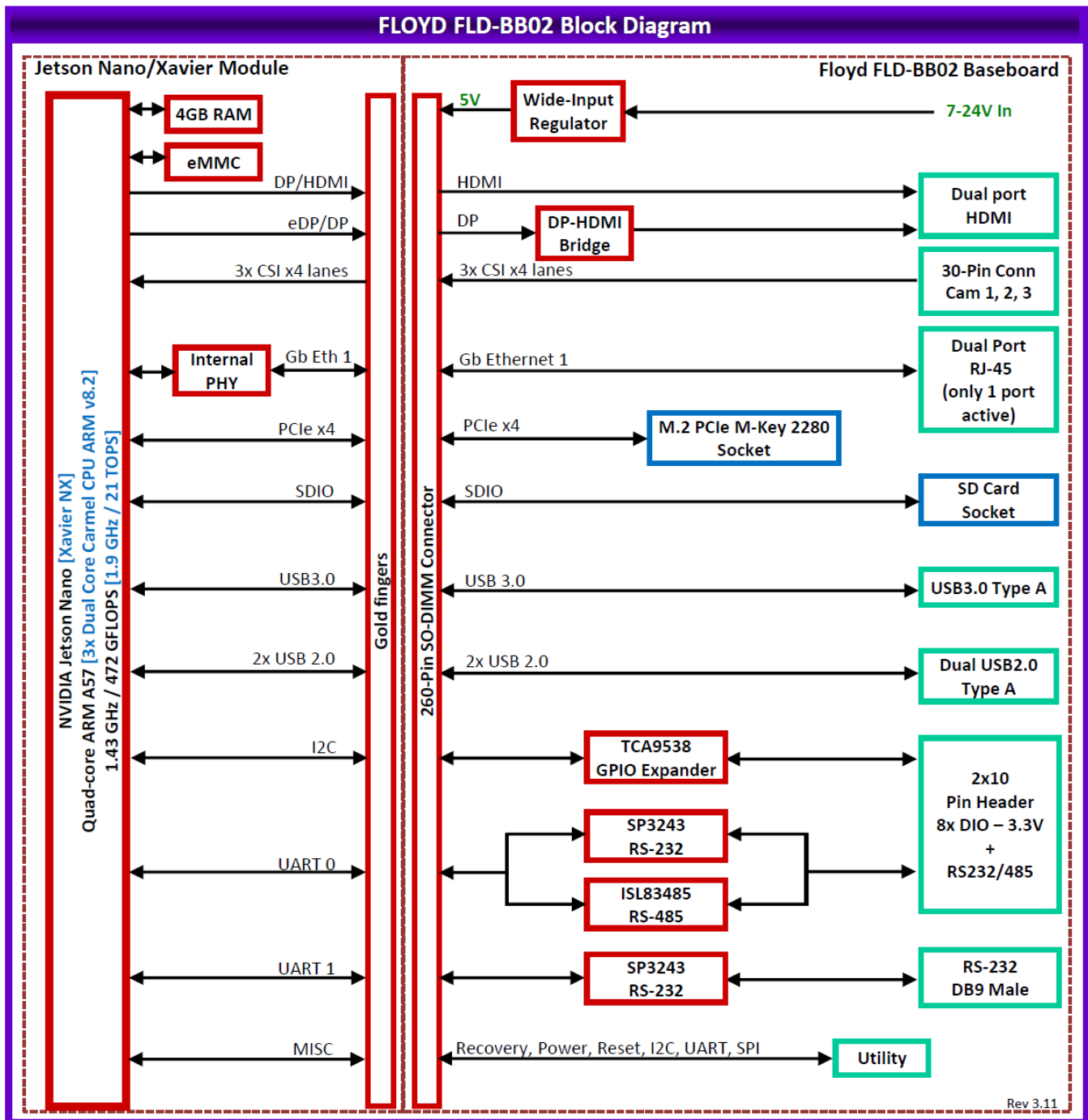

Figure 6-2: Floyd FLD-BB02 Carrier Board Functional Block Diagram

7. CONNECTOR AND JUMPER LOCATIONS

7.1 Main Component Locations

Figure 7-1 depicts the top callout view of the Floyd carrier board indicating the component locations.

A description of the components is tabulated below.

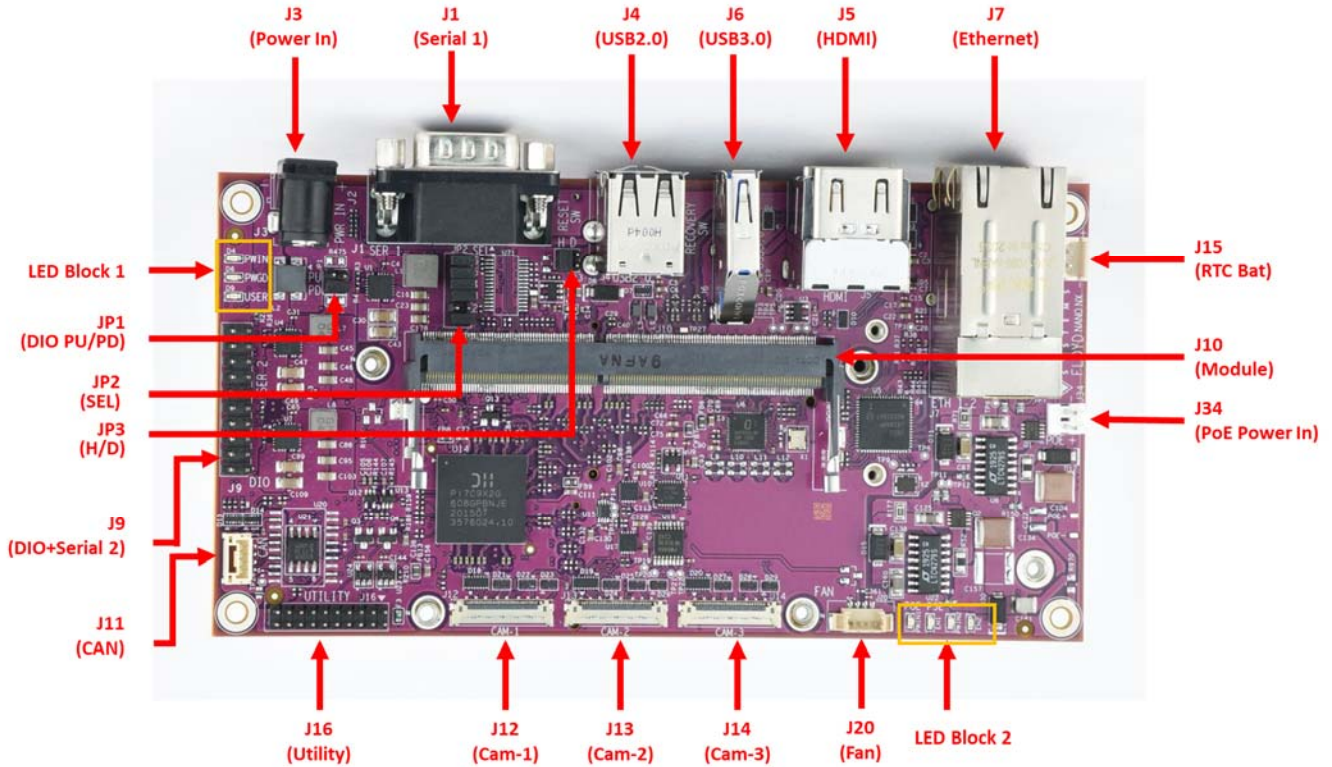

Figure 7-1: Floyd Top View

7.2 I/O Connectors, Jumpers and Led Specifications

The following table lists the I/O connectors marked in Figure 7-1 and their corresponding functions.

<i>Connector</i>	<i>Function</i>
J1	Serial Port 1
J3	Power In
J4	USB 2.0
J5	HDMI
J6	USB 3.0
J7	Ethernet
J9	DIO and Serial Port 2
J10	Module
J11	CAN

<i>Connector</i>	<i>Function</i>
J12	Camera 1
J13	Camera 2
J14	Camera 3
J15	RTC Battery
J16	Utility
J20	Fan
J34	PoE Power In

The following table lists the Jumpers marked in Figure 7-1 and their corresponding functions.

<i>Jumper</i>	<i>Function</i>
JP1	Digital I/O Pull Up/Down
JP2	Protocol Mode Selection, Serial Termination
JP3	USB2.0 port 1 Host/Device Select

The following table lists the LED Blocks marked in Figure 7-1 and their corresponding functions.

<i>LED Block 1</i>	<i>Description</i>
PWIN	Power In
PWGD	Power Good
USER	User LED
<i>LED Block 2</i>	
PWIN1	Power In for PoE on ETH-1
EN1	Enable PoE on ETH-1
PWIN2	Power In for PoE on ETH-2
EN2	Enable PoE on ETH-2

7.3 Front-Facing Connectors

Figure 7-2 depicts the front view of the Floyd carrier board. Most I/O features are accessible here, allowing for convenient and economical design of enclosures for Floyd.

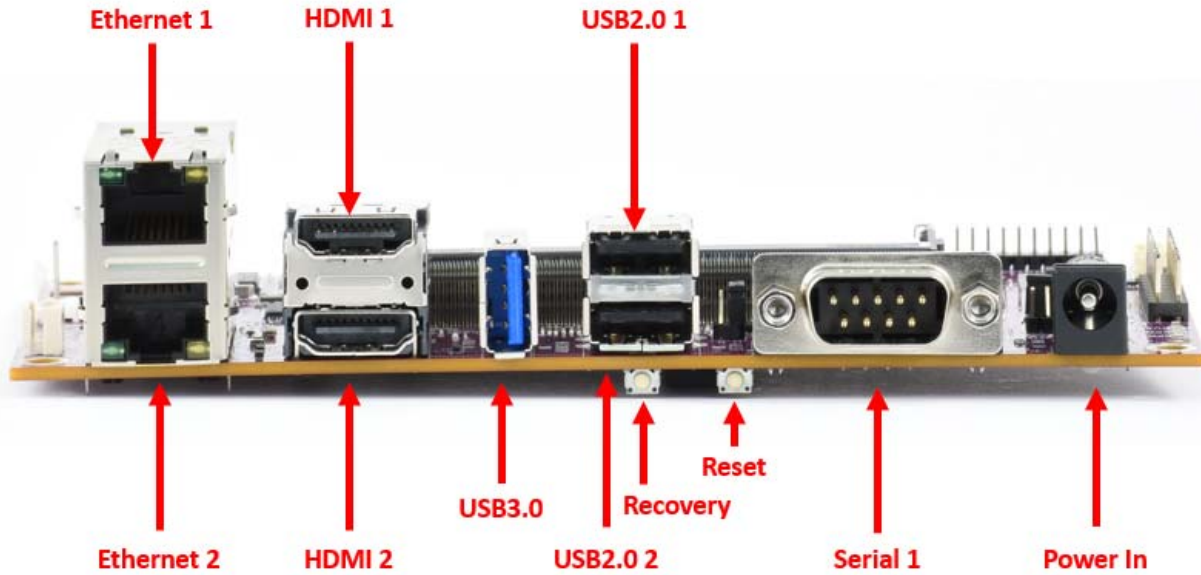

Figure 7-2: Floyd Front View

7.4 Expansion Slot and Switch Locations

Figure 7-3 depicts the bottom callout view of the Floyd carrier board indicating the location of expansion slots and switches.

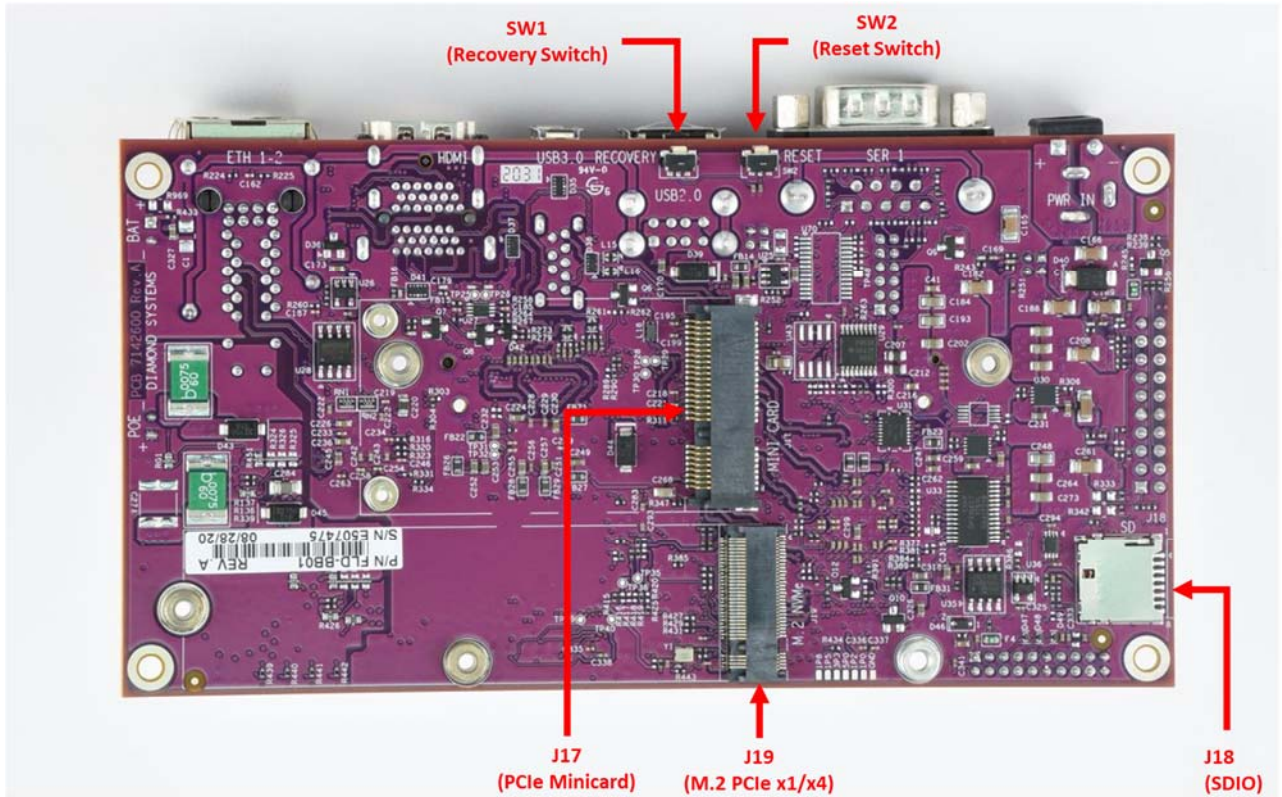

Figure 7-3: Floyd Bottom View

The following table lists the connectors and switches marked in Figure 7-3 and their corresponding functions.

<i>Connector</i>	<i>Function</i>
J17	mPCIe Module
J18	SDIO (Secure Digital Input Output) Module
J19	M.2 Module

<i>Switch</i>	<i>Function</i>
SW1	Recovery Switch
SW2	Reset Switch

8. I/O CONNECTORS

8.1 Power In Connector: J3

The carrier board provides a barrel connector for main input power. The connector has a 2.5mm center pin and is intended for use with mating connectors with 2.5mm inner diameter and 5.5mm outer diameter.

Input voltage = +7V to +24V

NOTE: The Jetson Nano Module is not hot-pluggable. Before installing or removing the module, the main power supply pins must be disconnected and the recommended wait-time of 1-minute must be allowed for the various power rails to fully discharge.

The connections for the power input connector are Tip = +V and Ring = -V.

Connector Part Number: PJ-202BH

8.2 PoE Power-In Connector: J34 (FLD-BB01 only)

The PoE power is supplied separately to the carrier board through a 1x2 connector.

VIN = +50VDC to +57VDC

The pinouts for the PoE power connector are specified below.

V_POE, 50-57VDC	1
Isolated Common	2

Connector Part Number/Type: 640456-2

DSC Mating Cable Part Number: 6981011 (Optional)

8.3 RTC Battery Connector: J15

The external battery input is intended for a 3V battery.

The pinouts for the RTC Battery connector are specified below. Pin 1 is identified with a white triangle.

3.0V RTC battery	1
Ground	2

Connector Part Number: 0022035025

DSC Mating Cable Part Number: 6980524

8.4 Camera Connectors: J12, J13, J14

The carrier board embeds three identical 30-pin connectors for multiple CSI Camera connectivity.

The 30-pin Micro Coaxial connectors are used to insert camera modules on the carrier board.

The pinouts for the CSI connectors are specified below.

J12		J13		J14	
1	V_3P3	1	V_3P3	1	V_3P3
2	V_3P3	2	V_3P3	2	V_3P3
3	V_1P8_CAM	3	V_1P8_CAM	3	V_1P8_CAM
4	GND_DIG	4	GND_DIG	4	GND_DIG
5	GND_DIG	5	GND_DIG	5	GND_DIG
6	CAM2_PWDN_1P8_E	6	CAM1_PWDN_1P8_E	6	CAM0_PWDN_1P8_E
7	CAM2_I2C_SCL_1P8_E	7	CAM1_I2C_SCL_1P8_E	7	CAM0_I2C_SCL_1P8_E
8	CAM2_I2C_SDA_1P8_E	8	CAM1_I2C_SDA_1P8_E	8	CAM0_I2C_SDA_1P8_E
9	GND_DIG	9	GND_DIG	9	GND_DIG
10	CSI2_D2_N	10	CSI1_D2_N	10	CSI0_D2_N
11	CSI2_D2_P	11	CSI1_D2_P	11	CSI0_D2_P
12	TRIG_CSI_CAM_2_R_E	12	TRIG_CSI_CAM_1_R_E	12	TRIG_CSI_CAM_0_E
13	SPI1_CLK_E	13	SPI1_CLK_E	13	SPI1_CLK_E
14	GND_DIG	14	GND_DIG	14	GND_DIG
15	CSI2_D1_N	15	CSI1_D1_N	15	CSI0_D1_N
16	CSI2_D1_P	16	CSI1_D1_P	16	CSI0_D1_P
17	GND_DIG	17	GND_DIG	17	GND_DIG
18	GND_DIG	18	GND_DIG	18	GND_DIG
19	CSI2_D0_N	19	CSI1_D0_N	19	CSI0_D0_N
20	CSI2_D0_P	20	CSI1_D0_P	20	CSI0_D0_P
21	NRST_CSI_CAM_2_E	21	NRST_CSI_CAM_1_E	21	NRST_CSI_CAM_0_E
22	GND_DIG	22	GND_DIG	22	GND_DIG
23	SPI1_SS2_E#	23	SPI1_SS1_E#	23	SPI1_SS0_E#
24	CSI2_CLK_N	24	CSI1_CLK_N	24	CSI0_CLK_N
25	CSI2_CLK_P	25	CSI1_CLK_P	25	CSI0_CLK_P
26	GND_DIG	26	GND_DIG	26	GND_DIG
27	CSI2_D3_N	27	CSI1_D3_N	27	CSI0_D3_N
28	CSI2_D3_P	28	CSI1_D3_P	28	CSI0_D3_P
29	FLASH_CAM_2_E	29	FLASH_CAM_1_E	29	FLASH_CAM_0_E
30	SPI1_MOSI_E	30	SPI1_MOSI_E	30	SPI1_MOSI_E

Connector Part Number: 20682-030E-02

Mating Cable Part Number: Compatible cables are generally included with the camera kit.

8.5 Controller Area Network (CAN) Connector: J11 (FLD-BB01 Only)

Floyd model FLD-BB01 implements one CAN Bus Controller port when integrated with the Jetson Xavier NX module. (The Nano module does not provide a CAN port.)

1	Ground
2	CAN Data -
3	CAN Data +
4	Ground

Connector Part Number: BM04B-GHS-TBT(LF)(SN)(N)

Connector Type: 1x4, 1.25 mm Pitch SMD

DSC Mating Cable Part Number: 6981182

8.6 Ethernet Connectors: J7

The Ethernet ports are terminated on a standard dual port PoE+ and RJ45 connector that has built-in magnetics and LEDs. The connector follows standard TIA/EIA 568B pinout.

1	Data A+	Orange / White
2	Data A-	Orange
3	Data B+	Green / white
4	Data C+	Blue
5	Data C-	Blue / White
6	Data B-	Green
7	Data D+	Brown / White
8	Data D-	Brown

Connector Part Number/Type: LPJG17098-8AENL

Mating Cable Type: Standard LAN CAT6 Cable

8.7 HDMI Connector: J5

Two HDMI ports are available on a dual-port vertical stacked standard connector. The connector follows the standard HDMI pinout.

D2+	1	2	D2 Shield
D2-	3	4	D1+
D1 Shield	5	6	D1-
D0+	7	8	D0 Shield
D0-	9	10	Clock +
Clock Shield	11	12	Clock -
CEC	13	14	N/C
DDC Clock	15	16	DDC Data
Groun	17	18	+5V
Hot Plug Detect	19		

Connector Type/ Part Number: QJ11191-DFB1-4F-AX3

Mating Cable Type: Standard HDMI Cable

8.8 USB 2.0 Port Connector: J4

The carrier board hosts two USB 2.0 ports accessible on a vertically stacked standard USB 2.0 Type A socket that uses standard pinout.

1	Vcc +5V
2	D-
3	D+
4	Ground

Connector Part Number: UB1112C-8FDH-4F

8.9 USB 3.0 Port Connector: J6

The carrier board hosts one USB 3.0 port accessed via an upright standard USB 3.0 receptacle.

Vcc +5V	1	9	SS TX+
D-	2	8	SS TX-
D+	3	7	Ground
Ground	4	6	SS RX +
		5	SS RX-

Connector Part Number: UEA3119C-4EB1-4H

8.10 Micro SD Connector: J18

The carrier board provides a standard Micro SD connector as an additional storage option.

1	DAT2
2	CD/DAT3
3	CMD
4	VDD 1.8V
5	Clock
6	Ground
7	DAT0
8	DAT1

Connector Part Number: 114-00841-68

Connector Type: Push/Pull

8.11 PCIe M.2 SSD Socket (M-KEY) Connector: J19

The Floyd carrier board is equipped with an M.2 PCIe SSD M-keyed connector for 2280 sized modules for storage applications. An M.2 SSD is "keyed" to prevent the insertion of a card connector to an incompatible socket on the board.

The PCIe link routing from the Jetson module to the M.2 socket varies according to the Floyd model.

- FLD-BB01:** The PCIe x4 link from the Jetson module is routed to a switch which provides 3 PCIe x1 links for the M.2 socket, PCIe minicard socket, and 2nd Ethernet port.
- FLD-BB02:** The x4 PCIe link is directly connected to the M.2 socket for maximum bandwidth. The minicard and 2nd Ethernet port are not present. With the Jetson Xavier NX module installed, an additional PCIe x1 lane interface can be mapped from the NX to the second Ethernet (contact Diamond Systems Corp for custom build options).

GND	1	2	3.3V
GND	3	4	3.3V
PETn3	5	6	N/C
PETp3	7	8	N/C
GND	9	10	LED1#
PERn3	11	12	3.3V
PERp3	13	14	3.3V
GND	15	16	3.3V
PETn2	17	18	3.3V
PETp2	19	20	N/C
GND	21	22	N/C
PERn2	23	24	N/C
PERp2	25	26	N/C
GND	27	28	N/C
PETn1	29	30	N/C
PETp1	31	32	N/C
GND	33	34	N/C
PERn1	35	36	N/C
PERp1	37	38	N/C
GND	39	40	N/C
PETn0	41	42	N/C
PETp0	43	44	N/C
GND	45	46	N/C
PERn0	47	48	N/C
PERp0	49	50	PERST#
GND	51	52	CLKREQ#
REFCLKN	53	54	PEWake#
REFCLKP	55	56	N/C
GND	57	58	N/C
KEY			
N/C	67	68	SUSCLK
PEDET	69	70	3.3V
GND	71	72	3.3V
GND	73	74	3.3V
GND	75		

Connector Part Number: 10128798-001RLF

Connector Type: M-Key

Add-on Module: M.2 2280 SSD (W 22 mm x L 80 mm)

8.12 PCIe Mini Card Connector: J17 (FLD-BB01 only)

The TX (Transmit) and RX (Receive) signals are transmitted by the host.

The TX signal channels on the socket and the RX signal channels on the Jetson modules are bi-directional. The RX signal on the socket is driven by the TX signal on the installed module and vice versa. The Chip Select (CS) control feature is available to generate commands on the SPI bus.

The two mounting standoffs at the far end of the Xavier Module installation site are not connected to Ground.

The pinouts for the PCIe Mini Card connector are specified below.

	1	2	+3.3V
	3	4	Gnd
	5	6	+1.5V
Clkreq-	7	8	
Gnd	9	10	
PCIe 1 Clk-	11	12	
PCIe 1 Clk+	13	14	
Gnd	15	16	
KEY			
	17	18	Gnd
	19	20	Disable-
Gnd	21	22	PCIe Reset-
PCIe 1 RX-	23	24	+3.3V
PCIe 1 RX+	25	26	Gnd
Gnd	27	28	+1.5V
Gnd	29	30	SMB Clk
PCIe 1 TX-	31	32	SMB Data
PCIe 1 TX+	33	34	Gnd
Gnd	35	36	
Gnd	37	38	
+3.3V	39	40	Gnd
+3.3V	41	42	WWAN LED-
Ground	43	44	WLAN LED-
	45	46	WPAN LED-
	47	48	+1.5V
Pull-up to +3.3V	49	50	Gnd
	51	52	+3.3V

Connector Part Number: MM60-52B1-E1-R650

8.13 Serial Port and GPIO Connectors: J1, J9

The carrier board is equipped with two serial ports from the Jetson module and 8 GPIO lines derived from a TCA9538 GPIO expander chip. In the standard configuration, the first serial port terminates on a DB9 connector J1 and the second serial port and the 8 GPIO lines terminates on a 2x10 pin header J9, and. As a special order, the GPIO lines can be rerouted to the DB9 connector in place of the first serial port.

Model FLD-BB01 supports RS-232, RS-422, and RS-485 protocols on both serial ports. Model FLD-BB02 supports only RS-232 on port 1 and RS-232 and RS-485 protocol on port 2. The protocol selection is made with jumper block JP2.

Connector J1 – Serial Port 1 (or GPIO)

<i>Pin No.</i>	<i>RS232</i>	<i>RS422</i>	<i>RS485</i>	<i>GPIO</i>
1	–	–	–	GPIO 0
2	RXD	RX+	–	GPIO 1
3	TXD	TX+	TX+/RX+	GPIO 2
4	–	–	–	GPIO 3
5	Ground	Ground	Ground	Ground
6	–	–	–	GPIO 4
7	RTS	TX-	TX-/RX-	GPIO 5
8	CTS	RX-	–	GPIO 6
9	–	–	–	GPIO 7

Connector Type: DB9M Connector

Connector Part Number: A-DS 09 A/KG-T2S

Mating Cable: Standard serial port cable with DB9 female connector

Pin header J9 contains the second serial port, the GPIO lines, Ground, and a convenience 3.3V power supply connection via a polyswitch that limits the current to 100mA to prevent damage from overcurrent or a short circuit.

Connector J9: GPIO & Serial Port 2

RS-485	RS-422	RS-232			RS-232	RS-422	RS-485
GPIO 0	GPIO 0	GPIO 0	1	2	GPIO 1	GPIO 1	GPIO 1
GPIO 2	GPIO 2	GPIO 2	3	4	GPIO 3	GPIO 3	GPIO 3
GPIO 4	GPIO 4	GPIO 4	5	6	GPIO 5	GPIO 5	GPIO 5
GPIO 6	GPIO 6	GPIO 6	7	8	GPIO 7	GPIO 7	GPIO 7
GND	GND	GND	9	10	3.3V	3.3V	3.3V
-	-	-	11	12	-	-	-
-	RX+	RX	13	14	RTS	TX-	TX/RX-
TX/RX+	TX+	TX	15	16	CTS	RX-	-
-	-	-	17	18	-	-	-
GND	GND	GND	19	20	-	-	-

Connector Type: 2x10, 2 mm Header

Connector Part Number: 220-97-36GB01

DSC Mating Cable Part Number: C-DB9M-2

8.14 Utility Connector: J16

The carrier board provides access to utility signals on a 2x10 header.

The pinouts for the utility connector are specified below.

+3P3	1	2	+5P0
Force Off 5P0	3	4	SPI SS 3P3
Force Recovery 1P8	5	6	SPI MISO 3P3
Power Button 5P0	7	8	SPI CLK 3P3
Reset 1P8	9	10	SPI MOSI 3P3
GND	11	12	GND
Debug UART RX 3P3	13	14	I2C CLK 3P3
Debug UART TX 3P3	15	16	I2C DATA 3P3
GND	17	18	GND
GND	19	20	GND

Connector Part Number: 220-97-36GB01

Connector Type: Connector: 2x10, 2 mm Header

8.15 Fan Connector: J20

The pinouts for the fan connector are specified below.

PWM	1
TACH	2
5V	3
GND	4

Connector Part Number: 0533980471-2

Supported Fan Model: Delta ASB0305HP-00CP4

9. I/O CONNECTOR LIST

The following table provides a summary of the I/O connectors on Floyd carrier board

<i>Function</i>	<i>Manufacturer</i>	<i>Part No.</i>	<i>Description</i>	<i>DSC Mating Cable</i>
Power In	CUI Inc.	PJ-202BH	Connector Power Jack x2, 5x5.5 mm, Solder	N/A
RTC Battery	Molex	0022035025	Connector Header Vertical, 2 Pos, 2.5 mm	6980524
Camera (x3)	I-PEX	20525-030E-02	30-Pin Micro Coaxial RA SMD	N/A
CAN	JST	BM04B-GHS-TBT(LF)(SN)(N)	Connector Header SMD, 4 Pos, 1.25 mm	6981182
Digital I/O	Oupiin	220-97-36GB01	Connector Header R/A, 20 Pos, 2x10, 2 mm	C-DB9M-2
Ethernet GbE	Link PP	LPJG17098-8AENL	Connector Dual Port, Vertical Stacked PoE+ RJ45	Standard
PoE Power In	TE	640456-2	Connector Header Vertical, 2 Pos, 2.54 mm	6981011 (Optional)
Fan	Molex	0533980471	Connector Header SMD, 4 Pos, 1.25 mm	N/A
HDMI	Foxconn	QJ11191-DFB1-4F-AX3	Connector Dual-Port, Vertically Stacked HDMI	Standard
M.2 Socket	Amphenol	10128798-001RLF	Connector Female, 67 Pos, 0.020 Gold	N/A
MMC	Amphenol	114-00841-68	Connector MicroSD Card, Push-Pull R/A	N/A
PCIe MiniCard	JAE	MM60-52B1-E1-R650	52-Pin Mini Card, Full-Size with PCB Mount Threaded Spacers	N/A
Serial Ports	Assman	A-DS 09 A/KG-T2S	Connector DSUB, 9-Position	Standard
	Oupiin	220-97-36GB01	Connector Header R/A, 20 Pos, 2x10, 2mm	C-DB9M-2
USB 3.0	Foxconn	UEA3119C-4EB1-4H	USB 3.0 A Type, Upright, T/H, 9 Pos.	Standard
USB 2.0	Foxconn	UB1112C-8FDH-4F	Dual USB A Type, Right Angle, T/H, 8 Pos	Standard
Utility	Oupiin	220-97-36GB01	Connector Header R/A, 20 Pos, 2x10, 2 mm	N/A
Jetson module connector	TE	2309413-1	DDR4 SODIMM, 260P, H 9.2, Standard	N/A

9.1 I/O Cables

Diamond Systems **C-DB9M-2**: 20-Pin, Dual-9-Way, 2.54 mm Pitch, Serial Cable interconnects to the dual **DB9M** serial cable and is required to connect the GPIOs and Serial Port 2 to the carrier board.

For model FLD-BB01 with installed Jetson Xavier NX module, Diamond Systems **6981182** CANBus cable is required to access the CAN port.

10. CONFIGURATION JUMPERS

10.1 Digital I/O Enable Pull-Up Pull-Down: JP1

The Jumper blocks on the Floyd carrier board can be configured to enable/disable pull up/pull down settings on the GPIOs using Jumper shunts.

The Digital I/Os on the board can be configured to pull-up to 3.3V or pull-down to GND through Jumper Block **JP1**.

By default, all Digital I/Os are in Pull-Down mode.

The Jumper configurations are specified in the following table and illustrated below.

Jumper Block JP1

<i>Jumper Position</i>	<i>Configuration</i>
PU	Enable pull-up on the DI/Os
PD*	Enable pull-down on the DI/Os
* Default Mode	

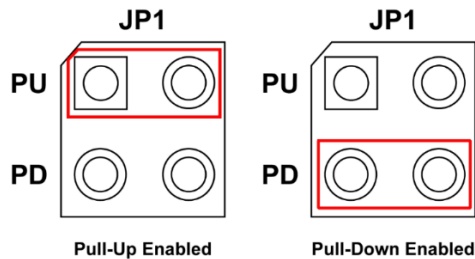

Figure 10-1: Jumper Block JP1 Configurations to Enable DIO Pull-Up/Pull-Down

10.2 Protocol Mode Selection and Enable Termination: JP2

The Jumper Block **JP2** provides the options to select RS232, RS422, and RS485 protocols on the serial ports. By default, Jumper position 1 in the RS232 in full-duplex mode is selected.

Jumper Block JP2

<i>Position 1</i>	<i>Position 2</i>	<i>Configuration</i>
In	Out	Serial Ports 1-2 RS-232 Mode (Default selection)
Out	In	Serial Ports 1-2 RS-485 Mode
Out	Out	Serial Ports 1-2 RS-422 Mode

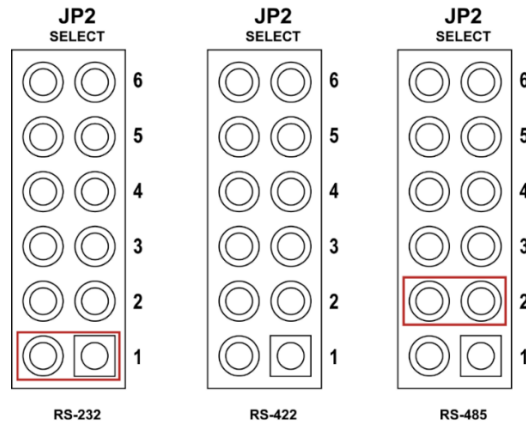

Jumper Block **JP2** also provides the capability to enable termination resistors on the serial ports in RS422/RS485 protocol modes. The Jumper configurations are specified in the following table and illustrated below. Normally both jumpers for a port will be either installed or uninstalled (3 and 4 together, 5 and 6 together).

Jumper Block JP2

<i>Jumper Position</i>	<i>Configuration</i>
3	121E Termination Enabled for SER2 TX RS-485/RS-422 Mode
4	121E Termination Enabled for SER2 RX RS-485/RS-422 Mode
5	121E Termination Enabled for SER1 TX RS-485/RS-422 Mode
6	121E Termination Enabled for SER1 RX RS-485/RS-422 Mode

Default: No jumpers are mounted. RS-232 is the default selected protocol.

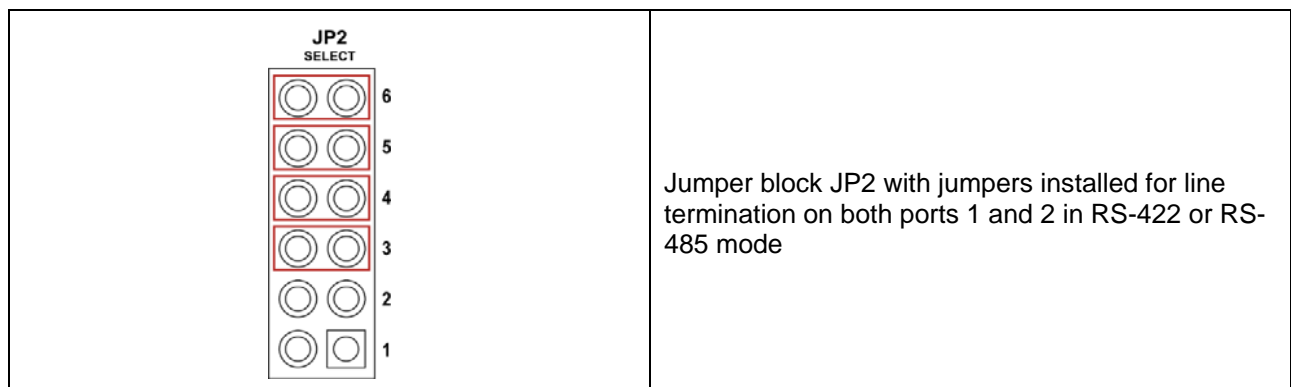

10.3 USB 1 Host/Device Select: JP3

The USB2.0 port 1 on the carrier board can be configured to function as a Host or a Device by selecting the Jumper positions on Jumper Block **JP3**.

When configured as a Host port, the USB port functions in the normal mode.

When configured as a Device, the USB port functions as an OTG (On-The-Go) device that implements RECOVERY mode to enable flashing the Jetson module(s).

By default, the USB2.0 port 1 port is configured as Host.

The Jumper configurations are specified in the following table and illustrated below.

Jumper Block JP3

<i>Jumper Block</i>	<i>Description</i>
D	USB2.0 port 1 Port as Device for Recovery Mode
H*	USB2.0 port 1 Port as Host in Normal Mode
* Default Mode	

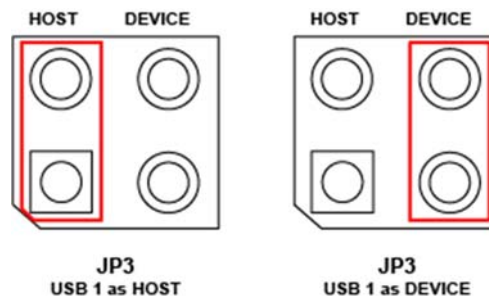

Figure 10-2: Jumper Block JP3 HOST and DEVICE Configurations on USB2.0 port 1

11. FLASHING THE BSP IMAGE

Jetson modules run a customized Linux operating system enhanced to work with the multi-core ARM processors and the GPU features unique to the module. The Linux operating system, referred to here as a board support package (BSP), is programmed into the built-in eMMC flash memory on the module. The stock module coming from distribution does not have any software programmed into it and must be programmed prior to use.

Diamond offers a separate BSP for both Nano and NX modules running on Floyd. These BSPs are based on the NVIDIA stock BSP R32.3.1 & R32.4.3 for Jetson Nano & Xavier NX respectively released by NVIDIA. The following is a list of interface feature enhancements added to the stock BSP.

Feature Enhancements

1. Added support and utilities for RS-232/422/485 serial port interfaces
2. Added driver support for E-Con cameras
3. Added utilities for camera connector interfaces, J12, J13, and J14
4. Added USB2.0 port 1 Host mode support
5. Added utility for I²C GPIO expander
6. Added support for MicroSD Card socket
7. Added User LED control

The Diamond Systems BSP is released as a compressed **tar.gz** file, that can be unzipped on a Linux Host Machine and flashed onto the Jetson Nano and Xavier Modules.

To update the image on the module, the Floyd carrier board must be set to Recovery Mode.

1. Remove the jumper on H from JP3 & mount it on D on JP3 as shown in [Section 10.3](#) to operate the USB2.0 port 1 as a device
2. Start the system by pressing the **RECOVERY (SW1)** button while powering up the board.
3. Connect the USB 2.0 Top Port 1 **J4** to the Host Linux PC using an USB A2A cable.

To verify that board is in recovery mode: In the Host PC running Ubuntu version 16.04 terminal application.

4. Issue the following command:

lsusb

The Terminal application will display the NVIDIA device listed under USB devices as depicted in the screen below that confirms that the system is in Recovery Mode and the module is ready to be flashed with the BSP Image.

NOTE: The image represented below has been captured from a Linux Host PC.

```
administrator@test:~$
administrator@test:~$ lsusb
Bus 001 Device 018: ID 0955:7c18 NVidia Corp.
Bus 001 Device 001: ID 1d6b:0002 Linux Foundation 2.0 root hub
Bus 005 Device 001: ID 1d6b:0001 Linux Foundation 1.1 root hub
Bus 004 Device 002: ID 093a:2510 Pixart Imaging, Inc. Optical Mouse
Bus 004 Device 001: ID 1d6b:0001 Linux Foundation 1.1 root hub
Bus 003 Device 001: ID 1d6b:0001 Linux Foundation 1.1 root hub
Bus 002 Device 002: ID 413c:2107 Dell Computer Corp.
Bus 002 Device 001: ID 1d6b:0001 Linux Foundation 1.1 root hub
administrator@test:~$
administrator@test:~$
```

Figure 11-1: Recovery Mode Terminal Screen

Flashing Jetson Nano Module

1. Download the BSP Image file **DSC-Floyd-Nano-release-2.0-20201016.tar.gz**, from the FTP site and copy it to a directory on the Linux Host Machine.

Alternatively, the file may be copied to a different source such as the Desktop.

2. Issue the following command to navigate to the directory containing the downloaded file:

```
cd ~/Desktop
```

To unzip the copied Image file:

3. Issue the following command depicted below.

```
sudo tar -pxvzf DSC-Floyd-Nano-release-2.0-20201016.tar.gzx
```

It may take a few minutes for the file to unzip.

NOTE: The **tar.gz** file name is liable to change according to the version and release date.

To switch to the directory where the file has been extracted:

4. Issue the following command as depicted below.

```
cd Linux_for_Tegra
```

To flash the Jetson Nano Module:

5. Issue the following command as depicted below.

```
sudo ./flash.sh jetson-nano-emmc mmcblk0p1
```

NOTE: Do not interrupt or interfere with the USB connectivity or the power supply to the carrier board until the flashing procedure is complete.

The flashing process will take 15-20 minutes to complete.

The system will automatically Reboot when the flashing process is complete.

6. Switch off the module and remove the recovery mode USB cable connection.

Flashing Jetson Xavier NX Module

1. Download the BSP Image file **dsc-floyd-nx-release-2.0-20201022.tar.gz** from the FTP site and copy it to a directory on the Linux Host Machine.

Alternatively, the file may be copied to a different source such as the Desktop.

2. Navigate to the directory containing the downloaded file, by using the following command:

```
cd ~/Desktop
```

To unzip the copied Image file:

3. Issue the following command depicted below.

```
sudo tar -pxvzf dsc-floyd-nx-release-2.0-20201022.tar.gz
```

It may take a few minutes for the file to unzip.

NOTE: The **tar.gz** file name is liable to change according to the version and release date.

To switch to the directory where the file has been extracted:

4. Issue the following command as depicted below.

```
cd Linux_for_ Tegra
```

To flash the Jetson Xavier NX Module:

5. Issue the following command as depicted below.

```
sudo ./flash.sh jetson-xavier-nx-devkit-emmc mmcblk0p1
```

NOTE: Do not interrupt or interfere with the USB connectivity or the power supply to the carrier board until the flashing procedure is complete.

The flashing process will take 15-20 minutes to complete.

The system will automatically Reboot when the flashing process is complete.

6. Switch off the module and remove the recovery mode USB cable connection.

With the BSP package installed the Floyd carrier board is ready for application development.

12. THERMAL SOLUTIONS

The Jetson Nano and NX modules dissipate up to 15W under high load and require a thermal solution for effective heat dissipation. Diamond systems offers both a heat sink, part no. 6882604, and a fan sink, part no. 6882601, for use on Floyd. Both items are identical except for the presence of a fan on the fan sink. Each part comes with all required installation hardware as well as thermal pads for high efficiency connection to the GPU chip on the Jetson module.

The heat sink and fan sink are not included with the Floyd carrier board but must be purchased separately. In Floyd complete systems such as the Jetbox-Floyd, the thermal solution is integrated into the enclosure, and no additional parts need to be purchased.

The fan specifications are shown below.

<i>Delta Electronics Model No. : ASB0305HP-00CP4</i>	
Operating Voltage range	4.5 - 5.5 VDC (5V nominal)
Power consumption	1.0W typical, 1.3W max
Speed	9500± 15% R.P.M.
Max. Air Flow (At Zero Static Pressure)	0.144 M ³ /Min. / 5.1 CFM
Connections	4-wire connector: 5V, Ground, PWM control, Tachometer
Size and Dimensions	Square. L 30 mm x H 30 mm 30 mm X W 6.9 mm
Type	Fan Blower; Tube Axial
RPM	9500 RPM
Material	Plastic
Weight	0.01 lb. (4.5 g)
Miscellaneous Features	Locked Rotor Protection, PWM Control, Speed Sensor (Tach)

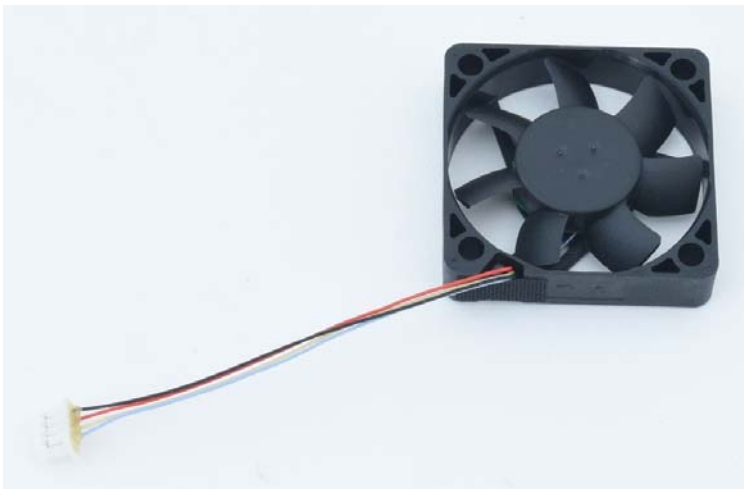

Figure 12-1: Floyd heat sink fan



Figure 12-2: Floyd with Heat Sink Installed



Figure 12-3: Floyd with Fan Sink Installed

13. SYSTEM ASSEMBLY

13.1 General Description

These instructions cover 3 tasks:

1. Install Jetson module
2. Install heat sink or fan sink
3. Install optional fan on heat sink (if not already present)

13.2 Required Parts

DSC P/N	QTY	DESCRIPTION
Varies	1	Floyd baseboard
6882601 Or 6882604	1	Floyd fan sink or heat sink
4810010	1	Fan (if not included with heat sink)
	4	M2.5 x 6.5mm long M/F spacers
	8	M2.5 x 10mm long pan head screws
	2	Thermal pads (one for Nano module, one for NX module)

13.3 Assembly Instructions

It is strongly recommended to use the DSC fan sink no. 6882601 or heat sink no. 6882604 for proper cooling. For higher temperature operation with high computing intensity, the fan sink is required.

See illustrations of heat sink, fan, and installation accessories below. The accessories are included with the heat sink.



6882601 heat sink



4810010 fan



Heat sink accessories

13.3.1 Install Jetson Module

1. If not present on board, install 2 M2.5 x 6.5mm long spacers along board edge. If heat sink will be installed, also install 2 spacers next to module connector. See illustration.

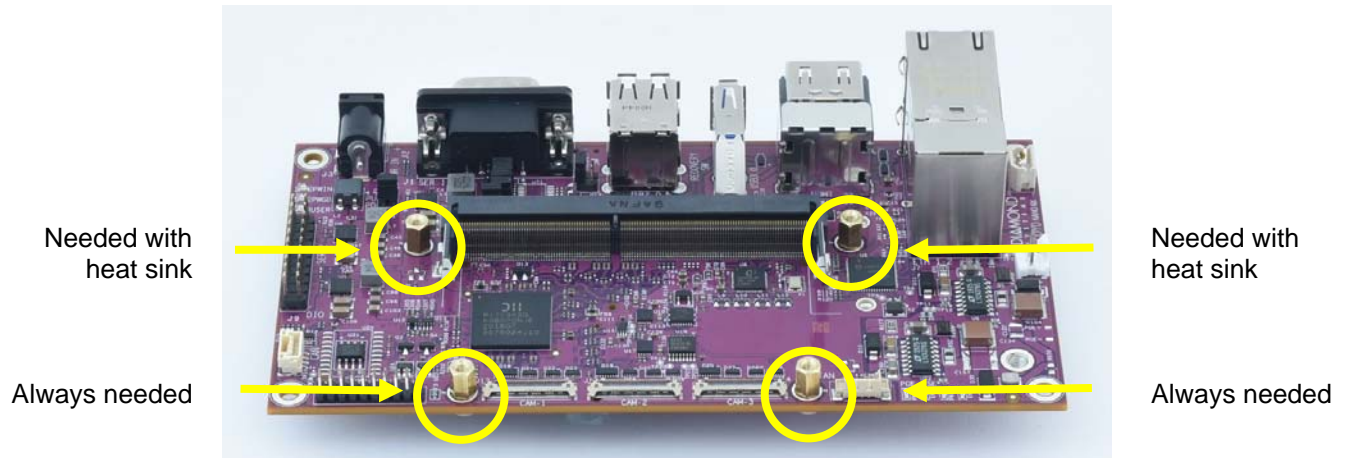

2. Insert module into socket at 45 degree angle. See illustration.



3. Push down module so that both side latches click fully into position. You may need to push down on the module PCB and push in the latches because it is a tight fit. See illustration.

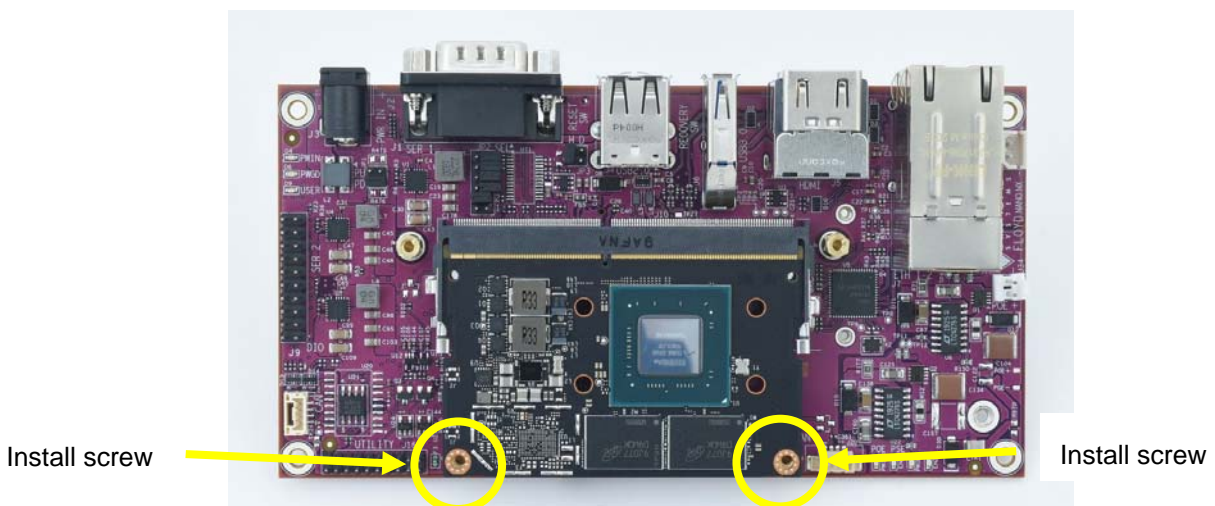

4. If heat sink will not be used, insert 2 M2.5 x 10mm long screws through module into spacers. See illustration above.

13.3.2 Install Heat Sink

1. First install module as described above. All 4 spacers must be installed. Do not install screws into Jetson module yet.
2. Place appropriate thermal pad for the Jetson module being used into appropriate location onto bottom of heat sink. See illustration. The NX module uses the larger pad, while the Nano module uses the smaller one. Only one or the other pad is needed; discard unused pad. Remove one liner to place the pad onto the heat sink. Then remove the second liner before installing the heat sink onto the module. If you do not remove the second liner, the thermal performance of the heat sink will be greatly reduced. This is a common oversight.

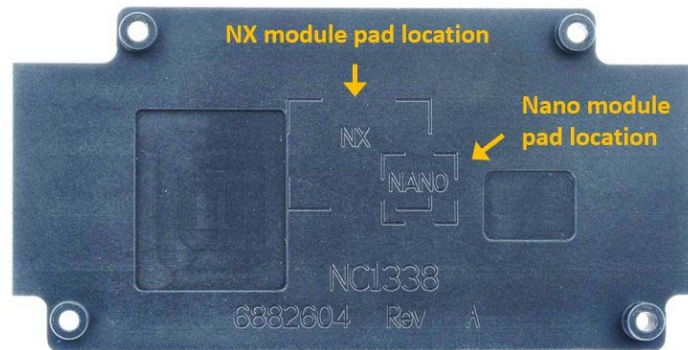

3. Place heat sink over module, aligning mounting holes with the 4 spacers on Floyd. Press down gently.
4. Install 4 M2.5 x 10mm long screws through the mounting holes into the spacers on Floyd. It is recommended to install all 4 screws loosely to ensure proper alignment, then tighten all 4 screws. See illustration.

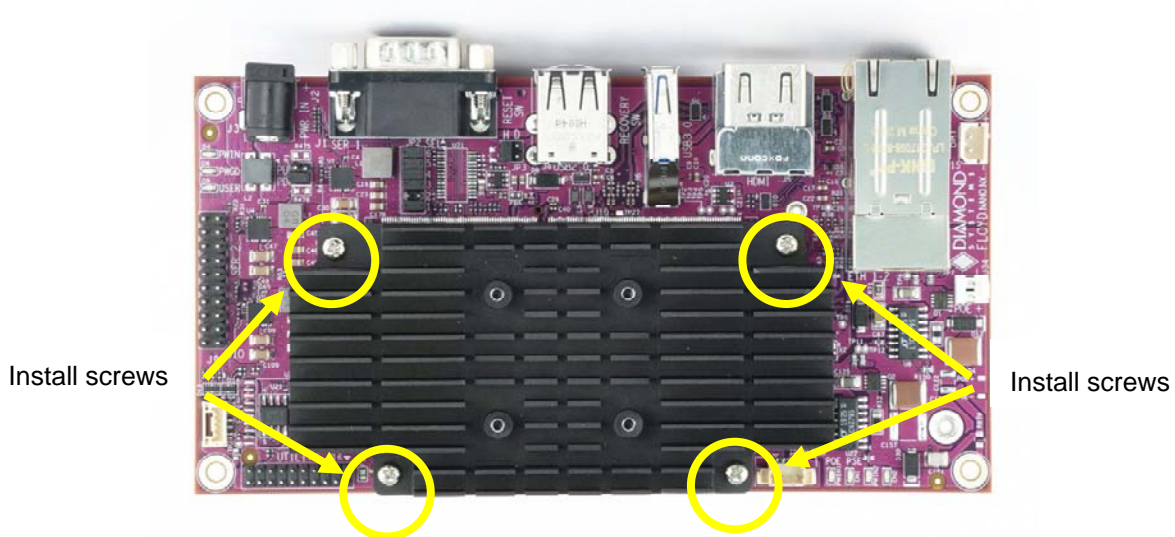

13.3.3 Install Fan

1. Place fan on heat sink in orientation shown in photo. Note the label is facing down (unseen in photo), and note the position of the 4-wire cable. In this orientation, air will blow down and out across the heat sink for improved heat dissipation.



2. Install 4 M2.5 x 10mm long screws to hold fan in place. It is recommended to install all 4 screws loosely to ensure proper fan alignment, then tighten all 4 screws.
3. Plug fan cable into board connector J20. Note carefully the proper orientation of the fan cable connector. The solid side faces out, while the side with the 4 visible contacts faces in. The fan connector is delicate and can be difficult to insert by hand. We recommend to use fine pliers to aid in the installation. Alternatively you can install the fan connector prior to installing the module and heat sink for easier finger access, then install it over the heat sink as a final step.

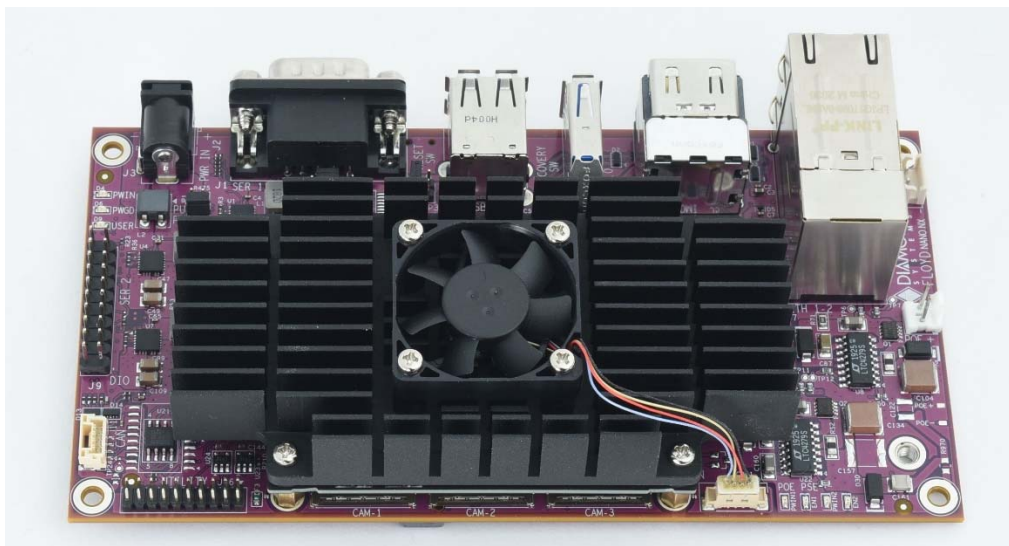
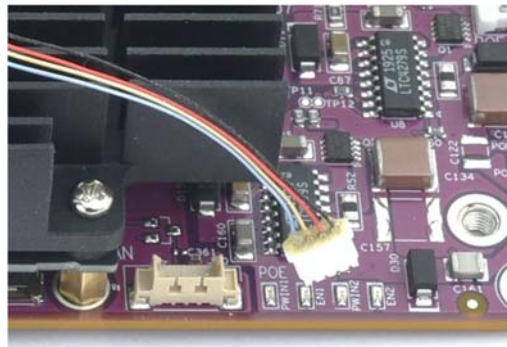

Finished assembly with heat sink and fan

14. SPECIFICATIONS

The Floyd carrier board Specifications are summarized in the following table.

Features	
Jetson Module	Jetson Nano or Jetson Xavier NX
Cooling Accessory	Heat sink (6882604) and Fan sink (6882601) accessories available
Camera Interface	3 x4 lane CSI-2 camera interfaces
CAN Interface	1x CAN 2.0 Non-isolated transceiver standard, isolation optional consult factory
Digital I/O	8x Digital IOs obtained through I ² C GPIO expander
Display	One HDMI 2.0 with integrated audio One HDMI 2.0 without audio
Ethernet	2x 10/100/1000 Mbps RJ45 with built-in magnetics and LEDs
Power over Ethernet	PSE, External 50-57VDC external supply required; Supports 2x PoE+ (25.5W max depending on supply capacity)
Mass Storage	1x mPCIe socket, full size 1x M.2 2280 M-Key PCIe socket 1x Micro-SD socket
Serial Ports	2x RS-232/422/485 Ports
USB Ports	2x USB 2.0, 1x USB 3.0
Utility	Force recovery, Power button, Reset, Debug UART, Force off, I ² C (3.3V), SPI (3.3V)
Digital I/O Specifications	
Device	TCA9538
Number of Lines	8
Direction	Programmable bit by bit
Logic levels	3.3V nominal outputs, 5V tolerant inputs
Pull resistors	10K ohms +/-1%; Jumper-selectable pull-up/down
Input voltage	
Logic 0:	-0.5V min, 0.66V max
Logic 1	2.64V min, 5.5V max
Output Voltage	
Logic 0:	0.0V min; 0.7V max @ 10mA output current
Logic 1	2.8V min @ -10mA output current; 3.3V max
Mechanical and Environmental Properties	
System Input Voltage	7-24VDC; Absolute Max input voltage = 26VDC
Dimensions	L 5.8" x W 3.04" (147.32 mm x 1 77.2 mm)
Weight	
Operating Temperature	-25°C to +75°C ambient
RoHS	Compliant

15. LIMITED WARRANTY POLICY

Diamond Systems Corporation warrants that its products will be free from defects and errors in material and workmanship and perform in full accordance with the technical specifications stated in the description of the product for a 2-Year Period from the Date of Shipment.

Unless otherwise stated, Diamond Systems Corporation Limited Warranty Policy covers the following criterion:

- It is extended to the original Purchaser/Consumer.
- Under Terms and Conditions of the Warranty, Diamond Systems Corporation, at its sole discretion, will repair or replace any defective parts or components of its product.
- The product must be returned to Diamond Systems Corporation in the-approved packaging, pre-authorized with a Diamond Systems Corporation-assigned Return Material Authorization (RMA) Number which is referenced on the shipping document.
- The Customer will prepay the shipment cost of the product to the Diamond Systems Corporation designated site.
- Diamond Systems Corporation will prepay the return shipping cost of the repaired or replaced the RMA product.

Diamond Systems Corporation Limited Warranty Policy does not cover product defects or damages incurred due to:

- Attempts by Customer to repair or resolve any product issues without the prior consent of Diamond Systems Corporation.
- Mishandling, misuse, neglect, normal wear, and tear, or accident.
- DIRECT, SPECIAL, INCIDENTAL OR CONSEQUENTIAL DAMAGES RESULTING FROM ANY BREACH OF WARRANTY OR CONDITION, OR UNDER ANY OTHER LEGAL THEORY, INCLUDING BUT NOT LIMITED TO LOST PROFITS, DOWNTIME, GOODWILL, DAMAGE TO OR REPLACEMENT OF EQUIPMENT AND PROPERTY, ANY COSTS OF RECOVERING, REPROGRAMMING, OR REPRODUCING ANY PROGRAM OR DATA STORED IN OR USED WITH DIAMOND SYSTEMS CORPORATION PRODUCTS, AND ANY FAILURE TO MAINTAIN THE CONFIDENTIALITY OF DATA STORED ON THE PRODUCT.

NOTE: THE LIMITED WARRANTY POLICY DOES NOT WARRANT TO REPAIR ANY OR EVERY DIAMOND SYSTEMS CORPORATION PRODUCT.
